

Company:

Date:

Contact Name:

PO #:

Email:

Address:

ORDER Quotation

Telephone:

Qty	Profile#	Height(Inch)	Width(Inch)	Size	# Side Gasket	Unit Model	Note
				<input type="checkbox"/> A <input type="checkbox"/> B <input type="checkbox"/> C	<input type="checkbox"/> 3 SIDE <input type="checkbox"/> 4 SIDE		
				<input type="checkbox"/> A <input type="checkbox"/> B <input type="checkbox"/> C	<input type="checkbox"/> 3 SIDE <input type="checkbox"/> 4 SIDE		
				<input type="checkbox"/> A <input type="checkbox"/> B <input type="checkbox"/> C	<input type="checkbox"/> 3 SIDE <input type="checkbox"/> 4 SIDE		
				<input type="checkbox"/> A <input type="checkbox"/> B <input type="checkbox"/> C	<input type="checkbox"/> 3 SIDE <input type="checkbox"/> 4 SIDE		
example 2	258	54 1/4	26 3/4	<input type="checkbox"/> A <input checked="" type="checkbox"/> B <input type="checkbox"/> C	<input type="checkbox"/> 3 SIDE <input checked="" type="checkbox"/> 4 SIDE	T23F	true cooler-5355707

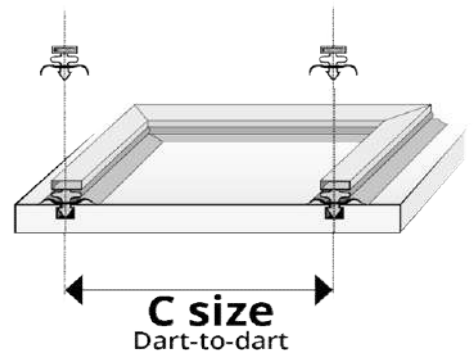
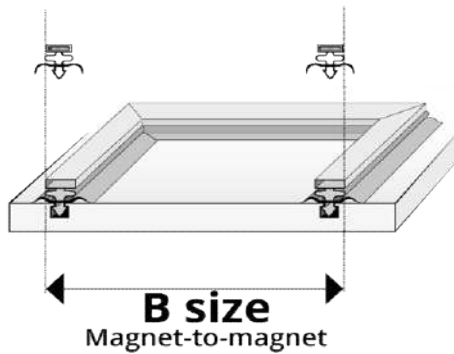
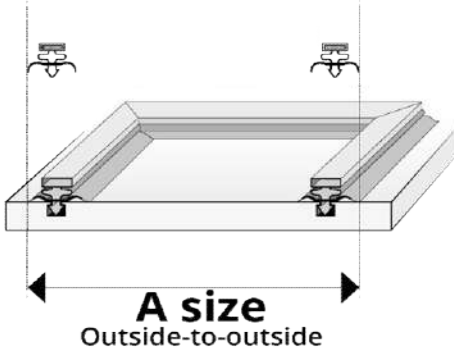

Note:

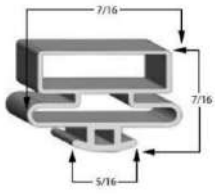

PROFILE-010

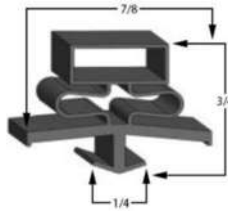

PROFILE-016

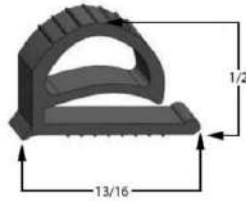

PROFILE-048

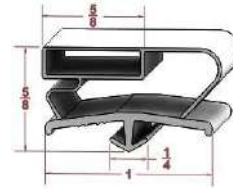

PROFILE-091

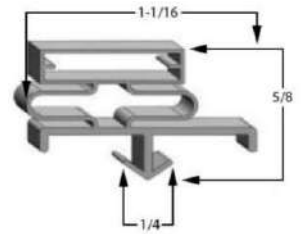

PROFILE-165

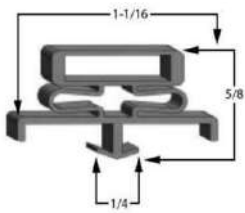

PROFILE-166

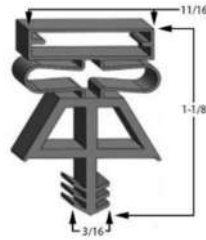

PROFILE-180

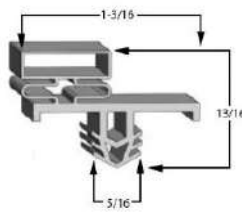

PROFILE-221

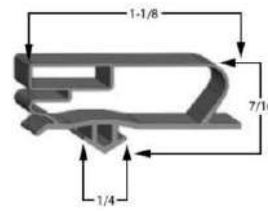

PROFILE-227

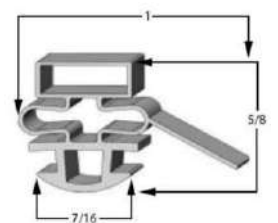

PROFILE-254

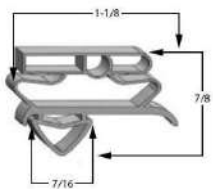

PROFILE-258

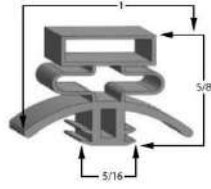

PROFILE-273

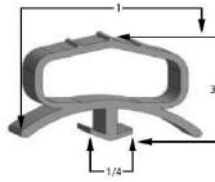

PROFILE-289

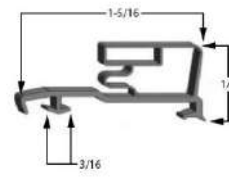

PROFILE-290

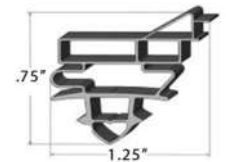

PROFILE-327

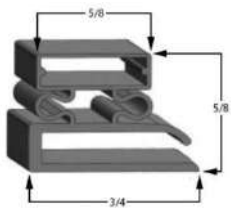

PROFILE-494

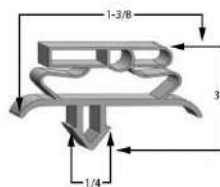

PROFILE-582

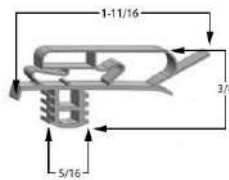

PROFILE-618



PROFILE-697

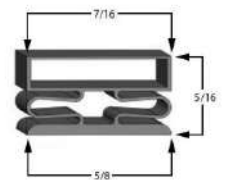

PROFILE-716

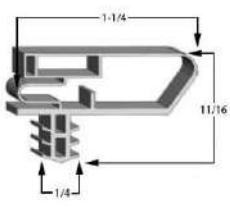

PROFILE-782

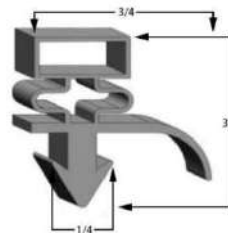

PROFILE-833

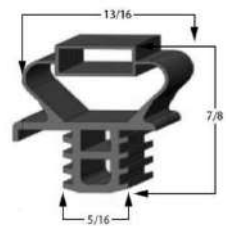

PROFILE-891

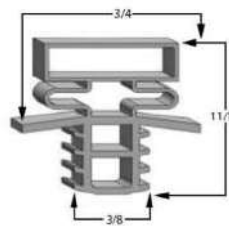

PROFILE-892

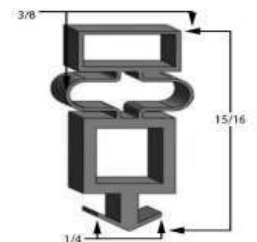

PROFILE-959